

Simplifying
hemostasis.

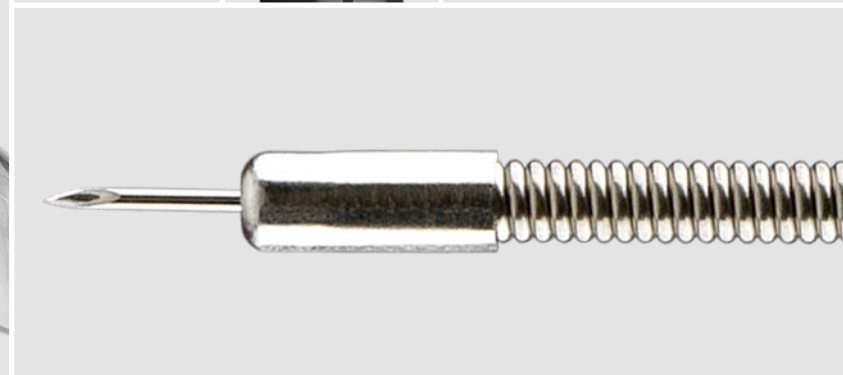

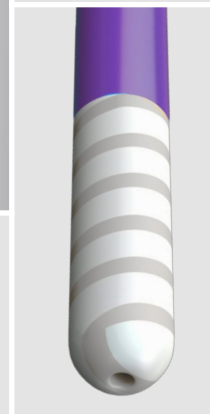
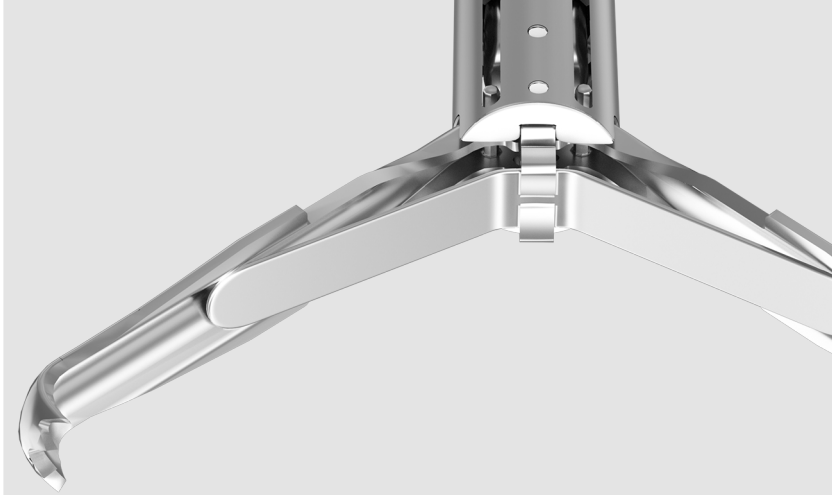
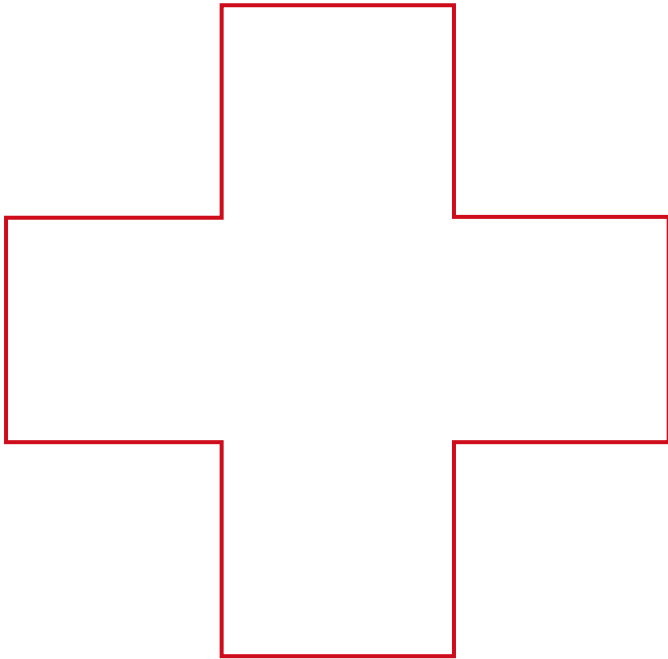

Simple solutions to complex problems.

The more simple and effective treatment options you have when treating gastrointestinal (GI) bleeds, the better your patient outcomes can be. Cook Medical provides those options with a wide variety of easy-to-use, efficient hemostasis devices.

Instinct Plus™ Endoscopic Clipping Device

CAUTION: U.S. federal law restricts this device to sale by or on the order of a physician (or a properly licensed practitioner).

INTENDED USE: This device is used for endoscopic clip placement within the gastrointestinal tract for the purpose of: 1. Endoscopic marking, 2. Hemostasis for • Mucosal/sub-mucosal defects less than 3 cm • Bleeding ulcers, • Arteries less than 2 mm, • Polyps less than 1.5 cm in diameter, • Diverticula in the colon, and • Prophylactic clipping to reduce the risk of delayed bleeding post lesion resection, 3. Anchoring to affix jejunal feeding tubes to the wall of the small bowel, 4. As a supplementary method for closure of GI tract luminal perforations less than 20mm that can be treated conservatively, 5. Anchoring to affix fully covered esophageal self-expanding metal stents to the wall of the esophagus in patients with fistulas, leaks, perforations, or disunion.

CONTRAINDICATIONS: Those specific to primary endoscopic procedure to be performed in gaining access to desired site. • Those specific to endoscopic hemostasis include, but are not limited to: uncooperative patient, coagulopathy, cricopharyngeal or esophageal narrowing or stricture, and tortuous esophagus.

WARNINGS: This device has not been evaluated for anchoring to affix fully covered esophageal self-expanding metal stents to the wall of the esophagus in patients with esophageal strictures or malignant obstructions.

POTENTIAL COMPLICATIONS: Those associated with gastrointestinal endoscopy and endoscopic hemostasis include, but are not limited to: perforation, hemorrhage, aspiration, fever, infection, allergic reaction to medication, hypotension, respiratory depression or arrest, cardiac arrhythmia or arrest, hematemesis, transient dysphagia, aspiration pneumonia, wound dehiscence, minimal acute inflammatory tissue reaction, transitory local irritation, migration of clip into the bile duct, and anatomy disruption.

See Instructions for Use for full product information.

AB_191002_REV1

DEVICES

MECHANICAL



4, 6, 10 Shooter™
Saeed® Multi-Band Ligator

- This device has been market leader in ligation for over two decades.
- The Opti-Vu® Barrel with recessed bands and friction fit adaptor is designed to optimize your endoscopic view while maintaining suction and a secure fit on the endoscope.
- Universal-fit barrels streamline ordering and simplify inventory control.

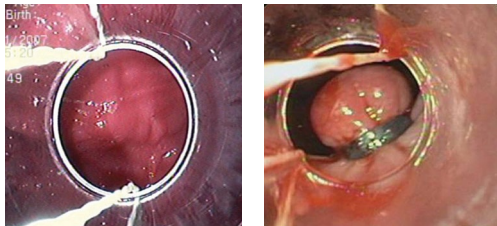

MECHANICAL



Instinct Plus™
Endoscopic Clipping Device

- The 360° jaw rotation provides complete control for precise clip placement.
- The adjustable 16 mm wide opening span facilitates grasping the amount of tissue desired.
- The intuitive handle and clip design provide for simple one-step clip detachment.
- The clip opens and closes up to five times for optimal positioning.
- The clip has anchoring tips for secure tissue grasping.
- The clips are MR Conditional per ASTM F2503.

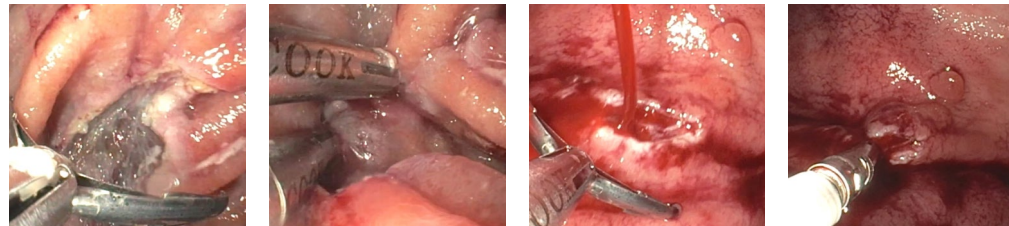

These images are used with the written permission of Dr. Shou Jiang Tang.

DEVICES

MECHANICAL



ShortShot®

Saeed Hemorrhoidal Multi-Band Ligator with TriView® Anoscope

- This device is preloaded so that multiple hemorrhoidal ligations can be performed in a single procedure.
- The TriView anoscope with positioning slots helps to optimize the anatomical positioning of hemorrhoids.
- Only a single insertion of an anoscope is required, potentially decreasing patient discomfort and procedure time

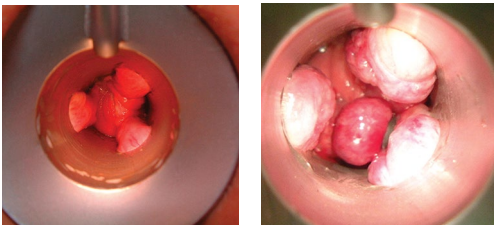

INJECTION



AcuJect®

Variable Injection Needle

- The needle advances and retracts smoothly.
- The clear outer catheter and white inner catheter allow visualization of needle advancement.
- The inner and outer catheters lock together to secure the advanced needle during injection.
- The needle length is adjustable.

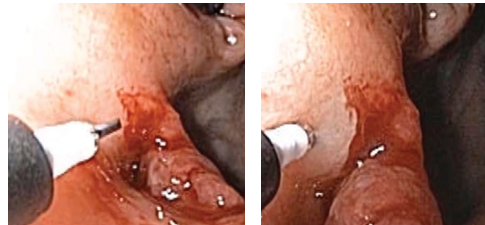

These images are used with the written permission of Dr. Shou Jiang Tang.

INJECTION

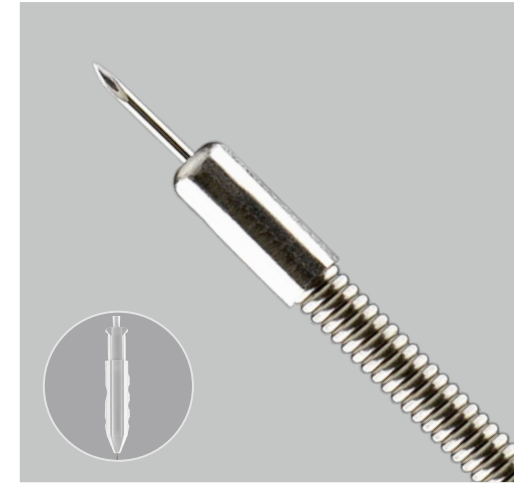

AcuJect Flex™

Injection Needle

- Used for the endoscopic injection of legally marketed sclerotherapy agents and dyes into esophageal or colonic varices.
- The ergonomically designed handle has a thumb-actuated needle extension for one-handed operation.
- The AcuJect Flex offers reliable and stable needle extension.
- The flexible stainless steel coiled sheath provides functionality in tortuous anatomical positions while helping to prevent kinking.

DEVICES

THERMAL

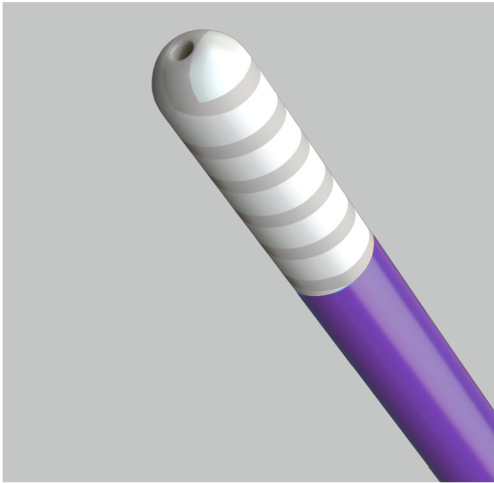

Quicksilver®
BiPolar Probe

- The Hydromer® grafted tip and spiral electrodes are designed to minimize sticking in order to facilitate effective coagulation.
- The lumen allows for irrigation.
- The 350 cm long catheter has single and dual plug options for optimal scope and generator compatibility.
- The device is completely disposable, eliminating cleaning and reprocessing costs.

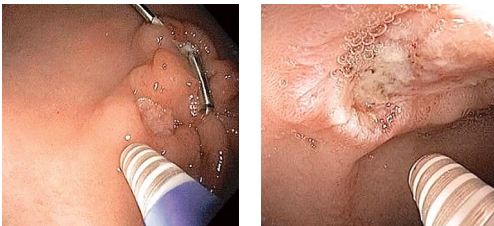

SPRAY



Hemospray®
Endoscopic Hemostat

- **Nonthermal:** The procedure causes no tissue changes, unlike some thermal modalities.
- **Atraumatic:** Since no force is applied at the treatment site, the powder minimizes the risk of tissue trauma that may result from other modalities.
- **Noncontact:** Aerosol delivery system eliminates the need for direct mechanical or contact forces with the treatment site by the delivery system.
- **Nonspecific targeting:** Powder is sprayed toward the source of the bleed, so it does not require the en face approach and the precise targeting of other modalities.
- **Simplifying hemostasis:** Just activate the CO₂ cartridge, open the valve, and spray toward the source of bleeding.

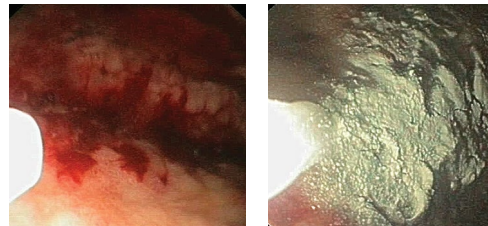

These images are used with the written permission of Alan Barkun, MD.

ORDERING INFORMATION

4, 6, 10 Shooter™ Saeed® Multi-band Ligator

| Order Number | Reference Part Number | Endoscope Outer Diameter mm | Bands | Trigger Cord Length cm |
|--------------|-----------------------|-----------------------------|-------|------------------------|
| G31915 | MBL-U-4* | 8.6–11.3 | 4 | 122 |
| G31917 | MBL-U-6* | 8.6–11.3 | 6 | 122 |
| G31919 | MBL-U-10* | 8.6–11.3 | 10 | 122 |
| G31918 | MBL-U-6-F* | 8.6–11.3 | 6 | 142 |
| G24654 | MBL-6-OV* | 9.5–11.5 | 6 | 122 |
| G22613 | MBL-4 | 9.5–13 | 4 | 122 |
| G22553 | MBL-6 | 9.5–13 | 6 | 122 |
| G22692 | MBL-6-F | 9.5–13 | 6 | 142 |
| G22614 | MBL-10 | 9.5–11.5 | 10 | 122 |

*Kit includes Opti-Vu barrel with ligation bands and trigger cord, loading catheter, precision control handle, and irrigation adapter. Minimum accessory channel diameter 2.8 mm.

CAUTION: Product contains natural rubber latex, which may cause an allergic reaction.

NOTE: The universal-fit barrels are not compatible with XL scopes.

Some products or part numbers may not be available in all markets. Contact your local Cook representative or Customer Support & Delivery for details.

Instinct Plus™ Endoscopic Clipping Device

| Order Number | Reference Part Number | Clip Opening Width mm | Catheter Fr | Catheter Length cm | Quantity | MR Status | Minimum Accessory Channel Diameter mm |
|--------------|-----------------------|-----------------------|-------------|--------------------|----------|----------------|---------------------------------------|
| G58010 | INSC-P-7-230-S | 16 | 7 | 230 | 10 | MR Conditional | 2.8 |

Some products or part numbers may not be available in all markets. Contact your local Cook representative or Customer Support & Delivery for details.

ShortShot® Saeed Hemorrhoidal Multi-Band Ligator with TriView® Anoscope

| Order Number | Reference Part Number | Bands |
|--------------|-----------------------|-------|
| G34063 | HMBL-4-TRI | 4 |

NOTE: Supplied with a TriView anoscope.

Some products or part numbers may not be available in all markets. Contact your local Cook representative or Customer Support & Delivery for details.

ORDERING INFORMATION

AcuJect®

Variable Injection Needle

| Order Number | Reference Part Number | Catheter Fr | Needle gage | Catheter Length cm |
|--------------|-----------------------|-------------|-------------|--------------------|
| G22525 | VIN-23 | 7 | 23 | 220 |
| G22526 | VIN-25 | 7 | 25 | 220 |

Some products or part numbers may not be available in all markets. Contact your local Cook representative or Customer Support & Delivery for details.

AcuJect Flex™

Injection Needle

| Order Number | Reference Part Number | Needle gage | Needle Deployment Length mm | Catheter Length cm | Quantity | Minimum Accessory Channel Diameter mm |
|--------------|-----------------------|-------------|-----------------------------|--------------------|----------|---------------------------------------|
| G57784 | AJ-FLEX-25-230-10 | 25 | 5 | 230 | 10 | 2.8 |

Some products or part numbers may not be available in all markets. Contact your local Cook representative or Customer Support & Delivery for details.

Quicksilver®

BiPolar Probe

| Order Number | Reference Part Number | Catheter Fr | Catheter Length cm | Generator Plug Type |
|--------------|-----------------------|-------------|--------------------|---------------------|
| G57188 | BCP-10AX | 10 | 350 | dual |
| G57189 | BCP-10BX | 10 | 350 | single |

Some products or part numbers may not be available in all markets. Contact your local Cook representative or Customer Support & Delivery for details.

Hemospray®

Endoscopic Hemostat

| Order Number | Reference Part Number | Catheter Fr | Catheter Length cm |
|--------------|-----------------------|-------------|--------------------|
| G56572 | HEMO-7 | 7 | 220 |
| G21049 | HEMO-10 | 10 | 220 |

Summary of clinical data: Clinical data summary information that was, in part, the basis for granting the de novo can be found on the Cook Medical website at [CookMedical.com/HemosprayData](https://www.cookmedical.com/HemosprayData)

Some products or part numbers may not be available in all markets. Contact your local Cook representative or Customer Support & Delivery for details.

Customer Service

EU Website: cookmedical.eu

EDI: cookmedical.eu/edi

Distributors: +353 61239240, ssc.distributors@cookmedical.com

Austria: +43 179567121, oe.orders@cookmedical.com

Belgium: +32 27001702, be.orders@cookmedical.com

Denmark: +45 38487607, da.orders@cookmedical.com

Finland: +358 972519996, fi.orders@cookmedical.com

France: +33 171230269, fr.orders@cookmedical.com

Germany: +49 6950072804, de.orders@cookmedical.com

Hungary: +36 17779199, hu.orders@cookmedical.com

Iceland: +354 800 7615, is.orders@cookmedical.com

Ireland: +353 61239252, ie.orders@cookmedical.com

Italy: +39 0269682853, it.orders@cookmedical.com

Netherlands: +31 202013367, nl.orders@cookmedical.com

Norway: +47 23162968, no.orders@cookmedical.com

Spain: +34 912702691, es.orders@cookmedical.com

Sweden: +46 858769468, se.orders@cookmedical.com

Switzerland - French: +41 448009609, fr.orders@cookmedical.com

Switzerland - Italian: +41 448009609, it.orders@cookmedical.com

Switzerland - German: +41 448009609, de.orders@cookmedical.com

United Kingdom: +44 2073654183, uk.orders@cookmedical.com

USA Website: cookmedical.com

EDI: cookmedical.com/edi.do

Americas:

Phone: +1 812.339.2235, 800.457.4500, Fax: 800.554.8335

E-mail: customersupport@cookmedical.com

Australia:

Phone: +61 734346000, 1800777222, Fax: +61 734346001, 1800077283

E-mail: cau.custserv@cookmedical.com



AI-ESC-IR-OHNS-PI-RH-SUR-A4