

Address transjugular procedures confidently with an array of specialized products.



PRODUCTS FOR TRANSJUGULAR
LIVER ACCESS AND BIOPSY

Cook Medical transjugular liver access and biopsy

For transjugular procedures, you need the flexibility to reach your objective and the precision to make your access count.

Cook Medical's specialized sets are purposely designed for the specific patient needs and physician preferences associated with transjugular liver procedures. The controlled maneuverability of Flexor® introducer sheaths, the precision of Quick-Core® biopsy needles, and a full range of accessory products work together to help you meet your objective.

Transjugular liver access

Rösch-Uchida technique

Rösch-Uchida Transjugular Liver Access Set 6

Colapinto technique

Ring Transjugular Intrahepatic Access Set 7

Transjugular liver biopsy

Core biopsy

Liver Access and Biopsy Set 9

Accessory products

One-Part Percutaneous Entry Needle 11

Introducers 11

Wire Guides 12

Dilators 13

Adapters and Stopcocks 14

Transjugular liver access

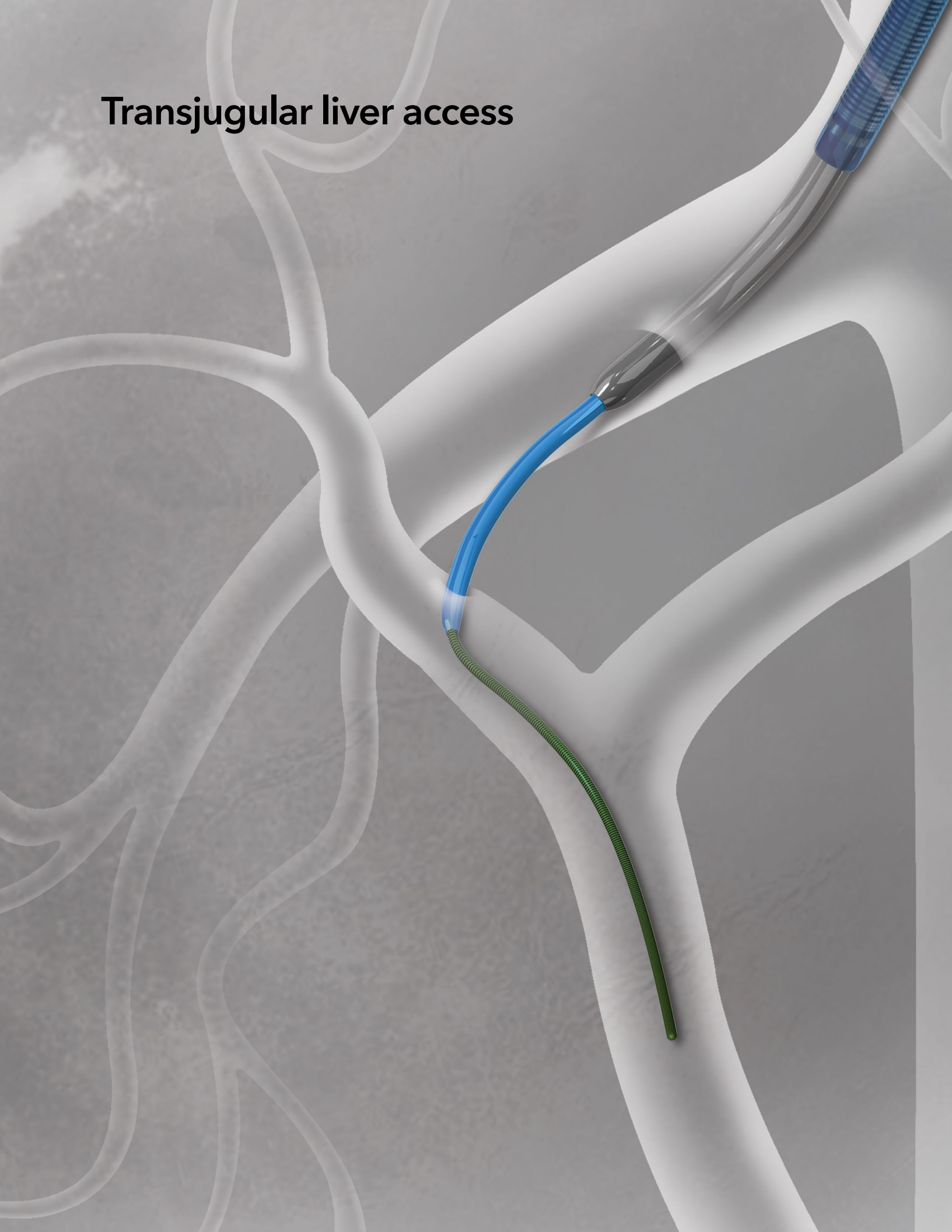



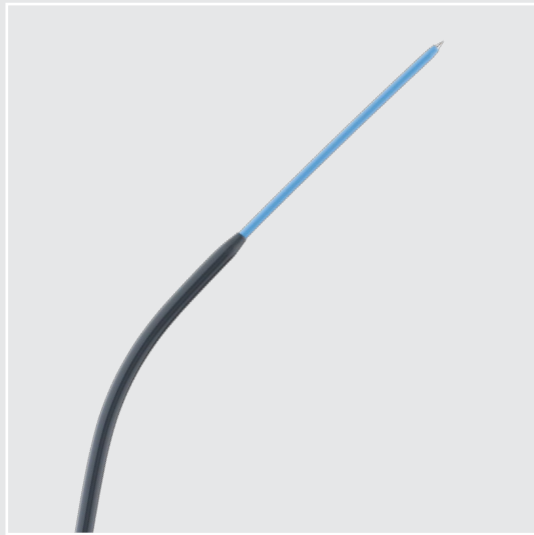

Rösch-Uchida

TRANSJUGULAR LIVER ACCESS SET

- Stiffening cannula provides added support during puncture.
- Trocar stylet facilitates vascular access within the liver for subsequent wire guide, catheter, and sheath placement.
- The Flexor® sheath design provides maximum flexibility without kinking or compression.
- Radiopaque band on introducer increases visibility for positioning accuracy.

Order Number	Reference Part Number	Introducer Fr/Length cm	Trocar Stylet Diameter inch	Trocar Stylet Length cm	Stiffening Cannula gage	Stiffening Cannula Length cm
Rösch-Uchida Transjugular Liver Access Set						
G06929	RUPS-100	10/40	0.038	62.5	14	51.5

Determine the maximum diameter of the instrument or catheter to be introduced to ensure its passage through the sheath.

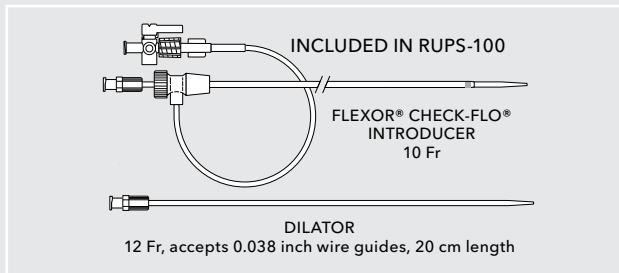
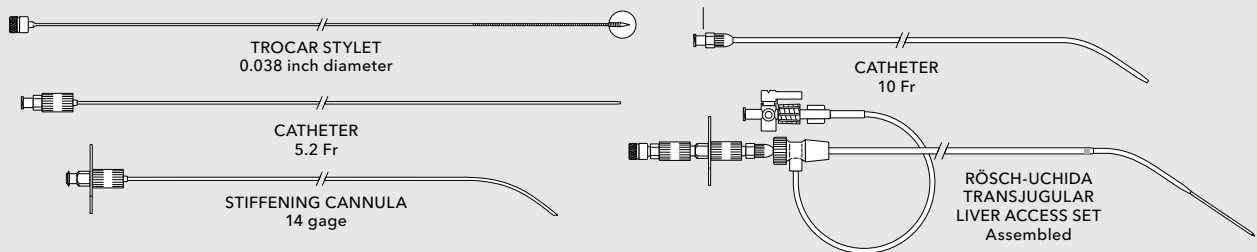



Ring

TRANSJUGULAR INTRAHEPATIC ACCESS SET

- Ross Modified Colapinto Needle facilitates vascular access within the liver for subsequent wire guide, catheter, and sheath placement.
- The Flexor® sheath design provides maximum flexibility without kinking or compression.
- Radiopaque band on introducer increases visibility for precise positioning.
- Availability in both 9 and 10 Fr sizes allows physician to address a variety of patient needs.

Order Number	Reference Part Number	Needle gage	Needle Length cm	Introducer Fr	Introducer Length cm
Ring Transjugular Intrahepatic Access Set					
G06541	RTPS-100	16	50.5	9	38.5
G29769	RTPS-100-10.0	16	50.5	10	38.5

Determine the maximum diameter of the instrument or catheter to be introduced to ensure its passage through the sheath.

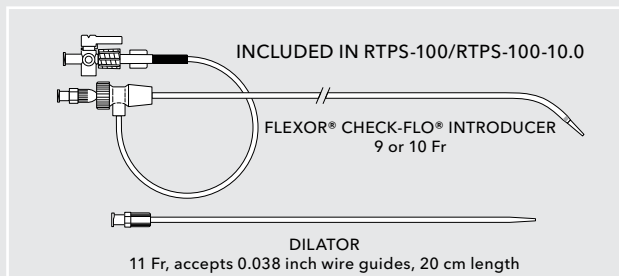
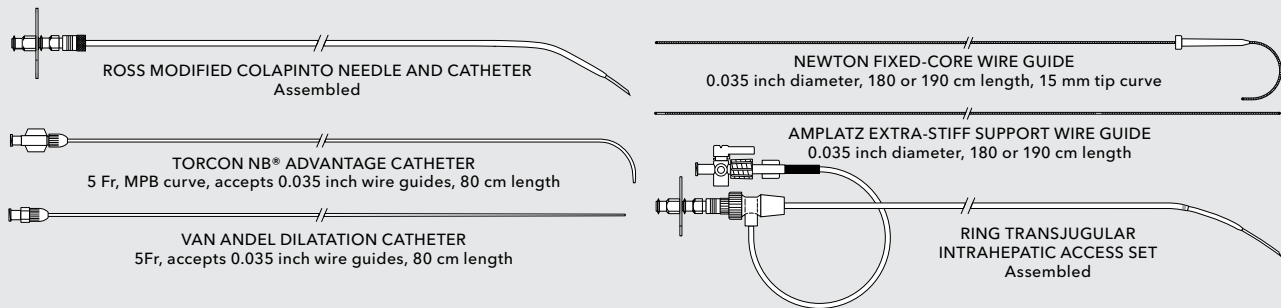

Transjugular liver biopsy

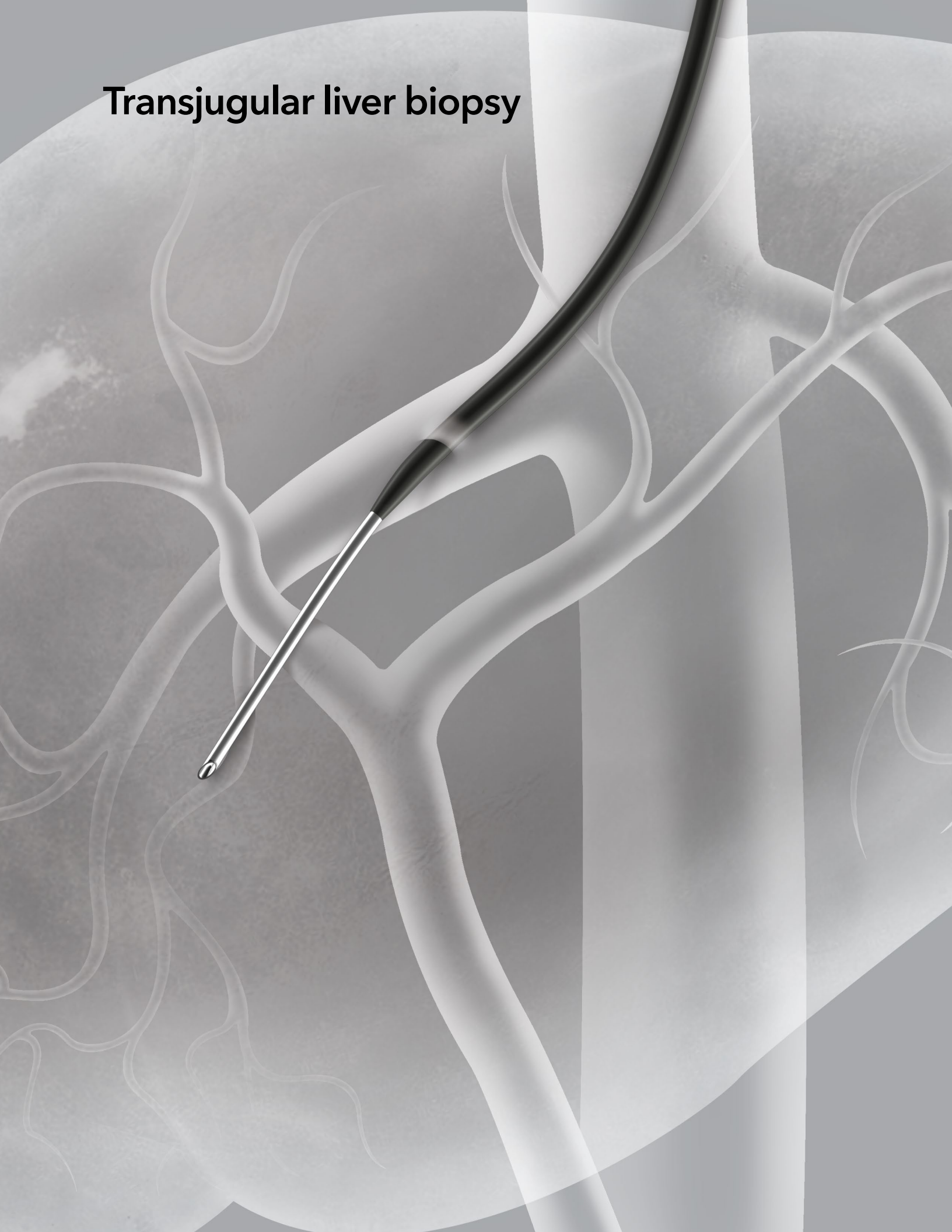

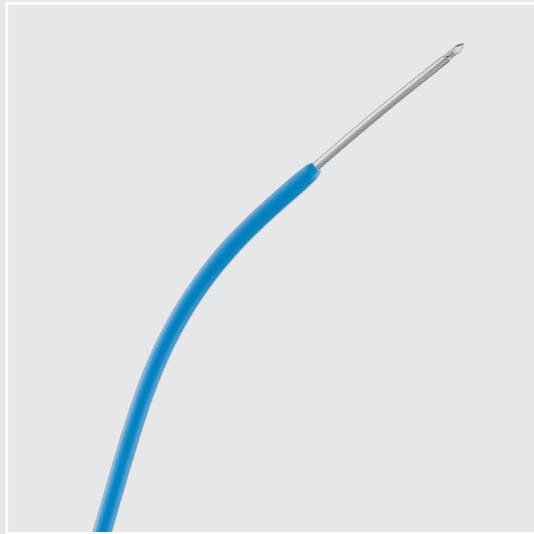

LABS

LIVER ACCESS AND BIOPSY SET

- The set includes a full complement of components for transjugular liver access and tissue biopsy.
- It is indicated for adult and pediatric use.
- Precurved catheter and cannula are ideal for hepatic vein access.
- Single-throw mechanical needle passes easily into tissue.
- Check-Flo Performer® adapter with sidearm tubing prevents blood reflux and allows the injection of contrast media or the aspiration of blood to confirm positioning.

Order Number	Reference Part Number	Needle gage	Needle Length cm	Needle Throw Length mm	Sheath Fr
Liver Access and Biopsy Set					
G57485	LABS-100-J-01	18	60	20	7
G57487	LABS-200-J-01	19	60	20	7
G57488	LABS-200-CHP-A-01	19	48	20	7
Liver Access and Biopsy Needle					
G57482	RMT-14XT-50.5-LABS-100-01	18	60	20	7
G57483	RMT-14XT-50.5-LABS-200-01	19	60	20	7

Determine the maximum diameter of the instrument or catheter to be introduced to ensure its passage through the sheath.

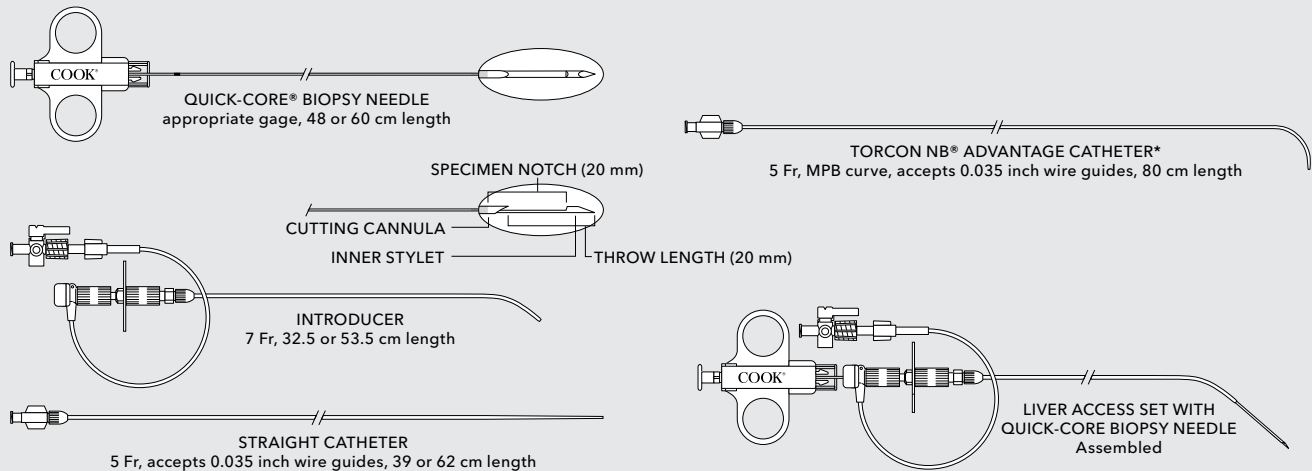

*Not in set LABS-200-CHP-A-01

Accessory products

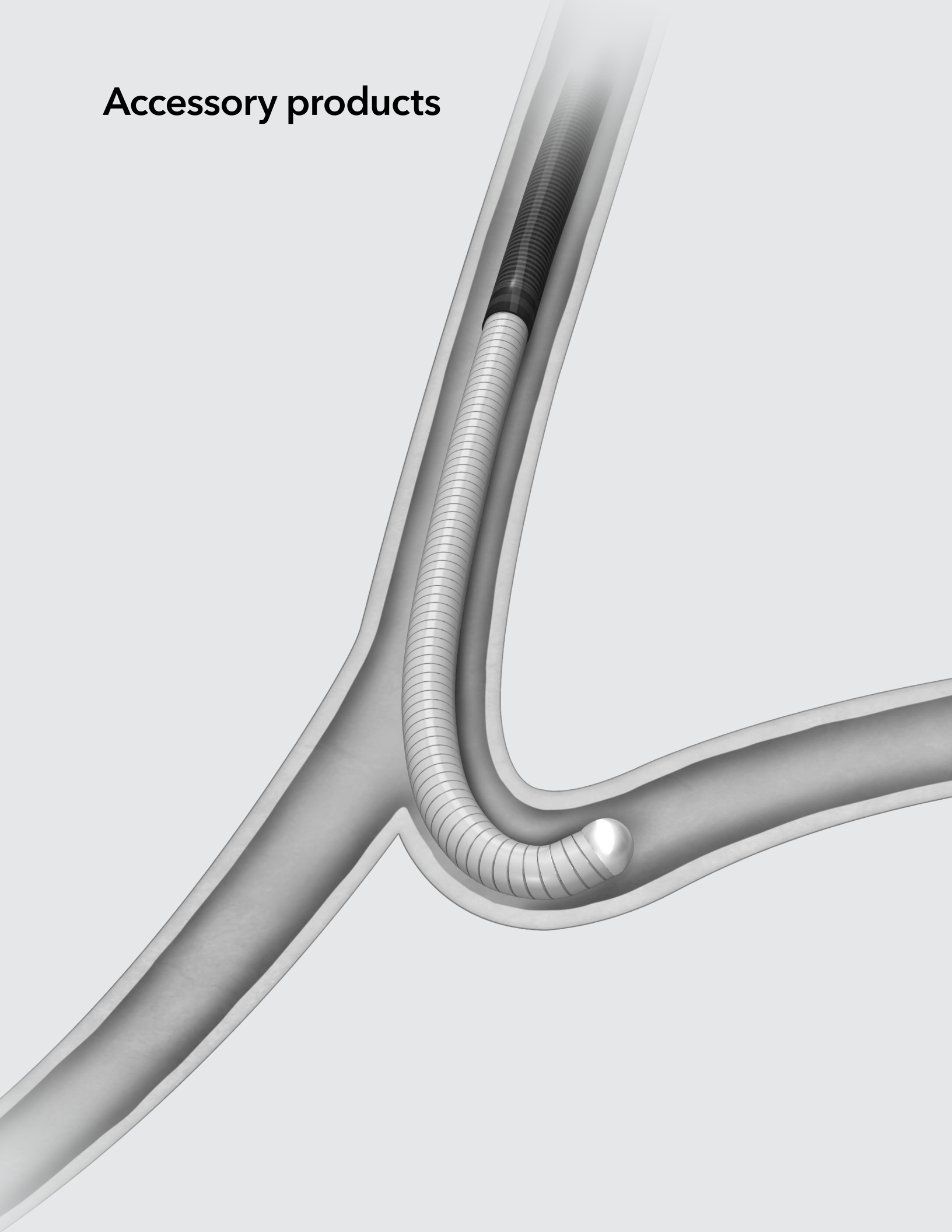

ACCESSORY PRODUCTS

One-Part Percutaneous Entry Needle



Order Number	Reference Part Number	gage	Length cm
Percutaneous Entry Thinwall Needle			
G00166	SDN-18-7.0	18	7
Percutaneous Entry Thinwall Needle (EchoTip®)			
G04717	SDN-18-7.0-U	18	7



Order Number	Reference Part Number	Catheter Fr	Catheter Length cm	Wire Guide Diameter inch	Wire Guide Length cm	Needle gage/Length cm
Micropuncture® Introducer Set						
G43872	MPIS-505-SST	5	10	0.018	40	21/7

Introducers

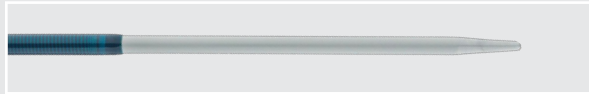

Order Number	Reference Part Number	Fr	Accepts Wire Guide Diameter inch	Length cm
Flexor® Check-Flo® Introducer Set				
G32233	KCFW-10.0-38-40-RB	10	0.038	40



Order Number	Reference Part Number	Fr	Accepts Wire Guide Diameter inch	Length cm
Flexor® Check-Flo® II Introducer Set				
G13160	KCFW-9.0-35-38.5-RB-RTPS-100	9	0.035	38.5
G13081	KCFW-10.0-35-38.5-RB-RTPS-100	10	0.035	38.5

ACCESSORY PRODUCTS

Wire Guides

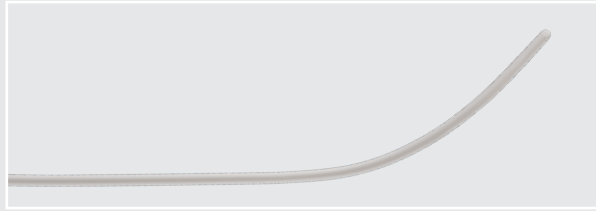

Order Number	Reference Part Number	Diameter inch	Length cm	Tip Configuration
Roadrunner® PC Wire Guide - The Firm™ (Hydrophilic, Stiff Shaft)				
G09534	RPC-35-80	0.035	80	angled
G06979	RPC-35-145	0.035	145	angled
G07518	RPC-35-180	0.035	180	angled
Roadrunner® UniGlide® Hydrophilic Wire Guide (Standard Shaft)				
G56172	HPWA-35-80	0.035	80	angled
G56173	HPWA-35-150	0.035	150	angled
G56174	HPWA-35-180	0.035	180	angled

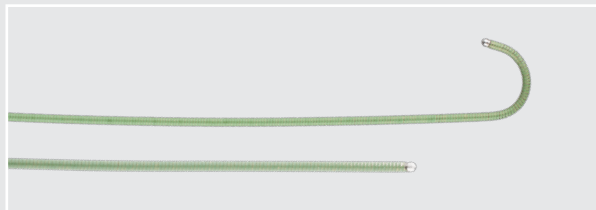

Order Number	Reference Part Number	Diameter inch	Length cm	Taper Length cm	Tip Curve Radius mm
Amplatz Extra Stiff Wire Guide					
G04003	THSF-35-80-AES	0.035	80	7	straight
G03095	THSF-35-145-AES	0.035	145	7	straight
G03330	THSF-35-180-AES	0.035	180	7	straight
G04237	THSCF-35-80-3-AES	0.035	80	7	3
G03203	THSCF-35-145-3-AES	0.035	145	7	3
G03565	THSCF-35-180-3-AES	0.035	180	7	3
Amplatz Ultra Stiff Wire Guide					
G10168	THSF-35-80-AUS	0.035	80	7	straight
G09954	THSF-35-145-AUS	0.035	145	7	straight
G09956	THSF-35-180-AUS	0.035	180	7	straight

ACCESSORY PRODUCTS

Dilators

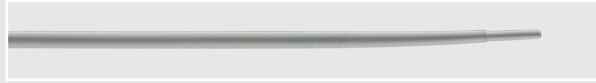

Order Number	Reference Part Number	Fr	Accepts Wire Guide Diameter inch	Length cm
Dilator (Standard)				
G00892	JCD7.0-35-20	7	0.035	20
G00973	JCD7.0-38-20	7	0.038	20
G00984	JCD8.0-35-20	8	0.035	20
G00980	JCD8.0-38-20	8	0.038	20
G00992	JCD9.0-38-20	9	0.038	20
G00993	JCD10.0-38-20	10	0.038	20
G00994	JCD11.0-38-20	11	0.038	20
G00995	JCD12.0-38-20	12	0.038	20
Dilator with AQ® Hydrophilic Coating				
G10208	JCD7.0-38-20-HC	7	0.038	20
G10289	JCD8.0-38-20-HC	8	0.038	20
G10290	JCD9.0-38-20-HC	9	0.038	20
G10207	JCD10.0-38-20-HC	10	0.038	20
G10292	JCD12.0-38-20-HC	12	0.038	20

Adapters and Stopcocks

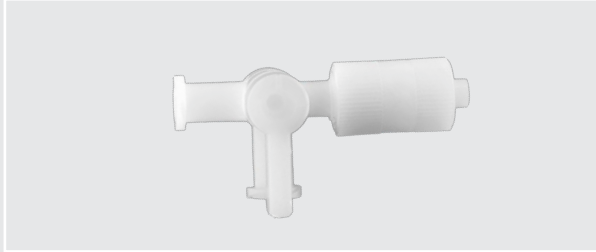

Order Number	Reference Part Number
Check-Flo® Hemostasis Assembly	
G06002	CFM-100
Plastic 3-Way Stopcock	
G00219	PTWS-2FLL-MLL-R

Customer Service

EU Website: cookmedical.eu
EDI: cookmedical.eu/edi
Distributors: +353 61239240, ssc.distributors@cookmedical.com
Austria: +43 179567121, oe.orders@cookmedical.com
Belgium: +32 27001702, be.orders@cookmedical.com
Denmark: +45 38487607, da.orders@cookmedical.com
Finland: +358 972519996, fi.orders@cookmedical.com
France: +33 171230269, fr.orders@cookmedical.com
Germany: +49 6950072804, de.orders@cookmedical.com
Hungary: +36 17779199, hu.orders@cookmedical.com
Iceland: +354 8007615, IS.orders@cookmedical.com
Ireland: +353 61239252, ie.orders@cookmedical.com
Italy: +39 0269682853, it.orders@cookmedical.com
Netherlands: +31 202013367, nl.orders@cookmedical.com
Norway: +47 23162968, no.orders@cookmedical.com
Spain: +34 912702691, es.orders@cookmedical.com
Sweden: +46 858769468, se.orders@cookmedical.com
Switzerland - French: +41 448009609, fr.orders@cookmedical.com
Switzerland - Italian: +41 448009609, it.orders@cookmedical.com
Switzerland - German: +41 448009609, de.orders@cookmedical.com
United Kingdom: +44 2073654183, uk.orders@cookmedical.com

USA Website: cookmedical.com

EDI: cookmedical.com/edi.do

Americas:

Phone: +1 812.339.2235, 800.457.4500, Fax: 800.554.8335

E-mail: customersupport@cookmedical.com

Australia:

Phone: +61 734346000, 1800777222, Fax: +61 734346001, 1800077283

E-mail: cau.custserv@cookmedical.com



AI, ESC, IR, OHNS, PI, RH, SUR-8.5X11